

ActionPro™

2.7K Digital Video Camera

30^{MP}_{Max} / 3.0" TFT

ActionPro™ FHD Digital Video Camera Instruction Manual



Model #: HDV17BK

HB Hamilton
Buhl®
Never-Ending Learning Innovation

Table of Contents

1. About	4
1a. System Requirements	4
1b. Camcorder Description Diagrams	4
1c. Button Functions/Descriptions	5
2. Using Your Camcorder	5
2a. Inserting Memory Card	5
2b. Installing the Battery	6
2c. Charging the Battery	7
2d. Turning On/Off Camcorder	7
2e. Changing Modes	7
2f. Connecting to a Computer	8
2g. Connecting to a Television	8
2h. Connecting to the External Microphone	8
2i. Video Recording Mode	9
2j. Camera Mode (for Photos)	9
2k. Zoom Function	10
2l. Using the LED light	10
3. Shooting Video and Settings	10
3a. Mode Settings	10
3b. Movie Size Settings	10
3c. Beauty Face Settings	11
3d. Exposure Settings (Adjusting EV Value)	11
3e. White Balance Settings	11
3f. Sharpness Settings (Adjusting Image Sharpness)	11
3g. Effect Settings (Selecting Image Effects)	11
3h. ISO Settings (Video Image Sensitivity)	11
4. Shooting Photos and Settings	12
4a. Mode Settings	12
4b. Resolution Settings	12
4c. Beauty Face Settings	13
4d. Shooting Settings	13
4e. Self-Timer Settings	13

4f.	Exposure Settings.....	13
4g.	White Balance Settings.....	13
4h.	Quality Settings (Photo)	13
4i.	Sharpness Settings	14
4j.	Effects Settings	14
4k.	ISO (Photo Sensitivity Settings)	14
4l.	Anti-Shake Settings	14
4m.	Face Detect Settings.....	14
4n.	Smile Capture Settings	15
4o.	Date Stamp Settings	15
5.	Playback Mode and Settings	15
5a.	Viewing Photos	15
5b.	Deleting Photos	15
5c.	Protecting Photos	16
5d.	Rotating Photos (Not Videos)	16
5e.	Cropping Photos (Not Videos)	16
5f.	Slideshow Presentation for Photos (Not Videos)	16
5g.	Playing Videos	16
5h.	Deleting Video Files	17
5i.	Protecting Video Files	17
6.	Basic Settings	17
6a.	Language Settings	17
6b.	Date and Time Settings	17
6c.	Auto Power Off Settings.....	17
6d.	Beep Settings	17
6e.	Light Frequency Settings	18
6f.	Formatting (Deletes All Files on Memory Card)	18
6g.	Default Setting	18
7.	Webcam Mode	18
8.	Appendix	19
8a.	Technical Specifications	19
8b.	Troubleshooting	20

1. About

1a. System Requirements

- Intel® Pentium processor 2.0 GH or higher
- Windows XP Operation System or later
- 2GB Memory, more than 40 GB disk space
- USB interface
- Display card cache memory 1 GB or higher
- Screen resolution of 1024x768 pixel or higher

1b. Camcorder Description Diagrams

[Front View]

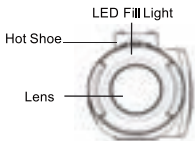

[Back View]

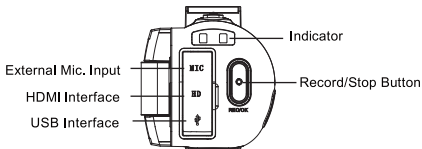

[Top View]

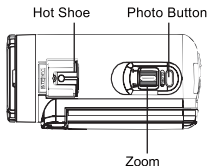

[Bottom View]

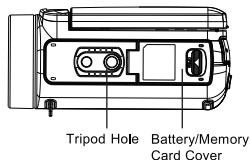



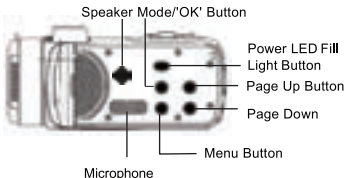



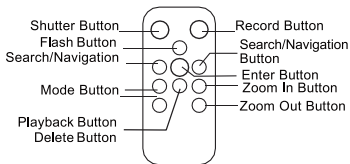





[Left View]



[Remote Control]



1c. Button Functions/Descriptions

Icon	Button Name	Function Description
	Power/ LED Light	Power on/off or LED light on/off
	Menu	Accesses Menu Mode
	Mode/Enter	Switches modes/select function in Menu  Camera Mode  Video Recording Mode or video file  Playback Mode
	Page Up	In playback mode, the cursor will move up to select desired photo or video file. In camera or video recording mode, press and hold the UP button to turn the icons on or off on the display. Press and hold again to turn icons back on the display.
	Page Down	In playback mode, Cursor will move down to select desired photo or video file
	Shutter	Takes photo in photo shooting mode
	Rec /Stop	Records or Stops video recording mode In Setting mode, press the button to confirm
	Zoom In/Out	*Zooms in and out in Camera Mode/Video Recording Mode; *Shrinks, magnifies or moves photos in playback mode
	Shutter Button····· Record Button····· Flash Button····· Search/Nav (-)····· Enter Button····· Search/Nav (+)····· Mode Button····· Delete Button····· Zoom In Button····· Zoom Out Button····· Playback Button·····	Takes photo Records on/off Flash light on/off Searches files or navigates in playback mode Selects menu in playback mode Searches files or navigates in playback mode Selects modes (Video, Photo or Playback) Deletes selected file Zooms in Zooms out Goes directly to playback mode

2. Using Your Camcorder

2a. Inserting Memory Card

Insert a memory card to store more photos and videos.

Information stored on a card will not be lost if you physically lock the card.

Insert the memory card according to the following steps:

1. Open the battery door (on the bottom) by pulling the lever – the door should pop open.
2. Metal contact part should go in first facing up, away from the battery. Insert and push the card in until it clicks into place.

Close the door, making sure it is fully locked. A memory card can only be inserted in the proper direction. **DO NOT FORCE THE CARD INTO THE SLOT.**



Attention!

Format your memory card before using. Do not take memory card out while recording as it will damage the card and may result in lost data.

Please check the compatibility of the memory card before using.

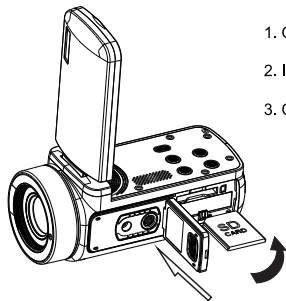

1. Open the battery cover in the direction as shown.
2. Insert the memory card in the direction as shown.
3. Close the battery cover as shown.

To ensure proper recording and playback of larger video files, it is suggested you purchase an additional Class 10 SD card.

2b. Installing the Battery

Install the rechargeable Lithium battery in the battery slot. A battery can only be installed in one specific direction. Do not force or push down hard on the battery. It will install easily if inserted correctly. Make sure the pins are inserted first, facing up.

**Attention!**

Please install the battery correctly or it may cause damage to the camera or other damage.

Do not use non-standard charger.

The power adapter for the camera is
AC 100V-240V/50-60Hz.

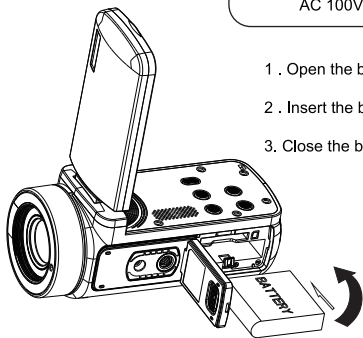

1. Open the battery cover in the direction as shown
2. Insert the battery into the cabin in the direction as shown
3. Close the battery cover as shown

2c. Charging the Battery

Connect a standard USB plug to a wall outlet and the other end of the mini-connector to the camcorder to properly charge. Make sure the shape of the mini-connector matches the charging jack on the camcorder. The charging jack can be found under the HDMI jack on the back of the unit.

2d. Turning On/Off the Camcorder

Press the 'Power' button to turn on the camcorder. Press and hold the 'Power' button for 2 seconds to turn off the camcorder. If battery power is running out, a 'Low Power' message will appear on the screen and the unit will turn itself off within a few seconds.

2e. Changing Modes

Press the 'Mode' button to change modes. Modes are: video recording, camera and playback mode. Each mode's icon will appear in the top left corner of the screen, when selected.

2f. Connecting to a Computer

In order to view videos and photos on your computer, connect the standard USB charging cable to your computer's USB terminal. The computer will recognize the camcorder as a removable drive; you will find your video and photo files in the subfolders.

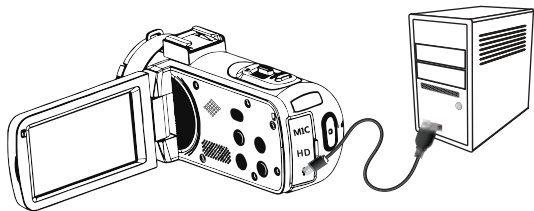

Connect the camcorder Mini-USB to a Standard-USB on a computer

2g. Connecting to a Standard Television

The camcorder can be connected to a TV to display video or photo files, as shown.

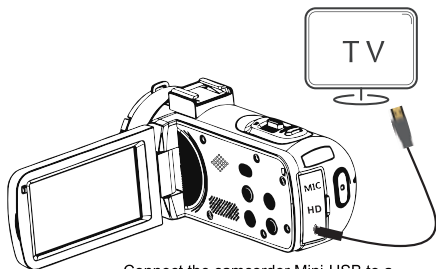

Connect the camcorder Mini-USB to a Standard-HDMI on a TV

2h. Connecting the External Microphone

For higher quality sound, the external microphone can be connected to the camcorder via 3.5mm external MIC input and slide into the hot shoe on the top of the camcorder.

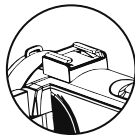

2i. Video Recording Mode

Press the 'Mode' button to select video shooting mode.

Options are:

1 Recording Mode	6 Memory Card	11 ISO
2 Video Resolution	7 Zoom	12 Exposure
3 Scene Mode	8 Battery	13 White Balance
4 LED Light	9 Effects	14 Menu
5 Recording Time	10 Sharpness	

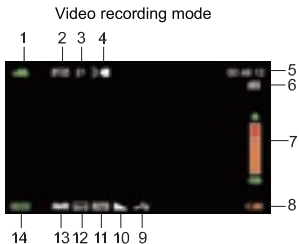

2j. Camera Mode (for Photos)

Press the 'Mode' button to select Camera Mode,

Options are:

1 Shooting Mode	7 LED Light	13 Sharpness
2 Photo Resolution	8 Remaining Number	14 ISO
3 Scene Mode	9 Memory Card	15 Exposure
4 Anti-Shake	10 Zoom	16 Photo Quality
5 Face Detection	11 Battery	17 White Balance
6 Smile Face Capture	12 Effects	18 Menu

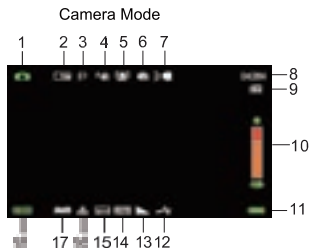

2k. Zoom Function

Zoom in by tilting the 'Zoom' lever to the right. Zoom out by tilting the 'Zoom' button to the left.

2l. Using the LED Light

The camcorder has a built-in LED light. It can compensate for a dark environment and help reduce shadows. In video recording or Camera Mode, press the 'Power' button to turn LED Light On/Off. The icon will show on the screen.



The LED light can be used in Camera Mode or video mode, operating the same way as the zoom function.

3. Shooting Video and Settings

Press the 'Mode' button to select Video Mode. The movie camcorder icon will appear on the top left corner of the display screen. You cannot take video without a memory card.

1. Look at the viewing screen to see your video capture. Hold the camcorder and press the 'Record/Stop' button to start recording.
2. When recording, the red circle icon will flash, Press the 'Shutter' button to pause/shoot. Press the 'Record/Stop' button again to end recording and save to memory.
3. The recorded files will autosave to the external memory card. Set parameters of the Video Mode before shooting.

3a. Mode Settings

The camcorder has multiple modes. Use Auto for general purpose filming.

1. From the 'Video Mode', press 'Menu'. Then, press the 'Up/Down' buttons to select the 'Mode Set' Option. Press 'OK' to enter the sub-menu.
2. Press the 'Up/Down' button to select: Auto, Night, Portrait, Landscape, Backlight, Sport, Party, Beach, High Sensitivity or Cancel.
3. Press 'OK' to save and return to Video Mode.

3b. Movie Size Settings

Different video resolutions options are: 2.7K (2888x1520), FHD (1920x1080), HD (1280x720), VGA (640x480) or Cancel. In higher resolution settings, the video image will be clearer, and the file size will increase as well.

1. From 'Video Mode', press 'Menu'. Then, press the 'Up/Down' buttons to select the 'Video Size' option. Press the 'OK' to enter sub-menu.
2. Press the 'Up/Down' buttons to select: 2.7K, FHD, HD, VGA or Cancel.
3. Press the 'OK' to save and return to the Video Mode.

3c. Beauty Face Settings

This function adjusts skin tones and may make a person's skin appear more natural, adjusting skin lightness and complexion.

1. From 'Video Mode', press 'Menu'. Then, press the 'Up/Down' buttons to select the 'Beauty Face' option. Press 'OK' to enter the sub-menu.
2. Press the 'Up/Down' buttons to select: On, Off or Cancel.
3. Press 'OK' to save and return to Video Mode.

3d. Exposure Settings (Adjusting EV Value)

You can adjust exposure depending on conditions (by deliberately under- or overexposing).

From 'Video Mode', press 'Menu'. Then, press the Up/Down buttons to select 'Exposure' option.

1. Press 'OK' for the sub-menu.
2. Press the 'Up/Down' buttons to select the EV value from +3 to -3 or Cancel.
A setting of '0' is a normal exposure.
3. Press 'OK' to save and return to Video Mode.

3e. White Balance Settings

Adjust color of your video according to different source conditions.

Use 'Auto' for general purpose use.

1. From 'Video Mode', press 'Menu'. Then, press the 'Up/Down' buttons and select 'White Balance'. Press 'OK' to enter the sub-menu.
2. Press the 'Up/Down' buttons to select Auto, Daylight, Cloudy, Fluorescent, Tungsten or Cancel. Press the 'OK' to save and return to Video Mode.

3f. Sharpness Settings (Adjusting Image Sharpness)

1. From 'Video Mode', press 'Menu'. Then, press the 'Up/Down' buttons to select the 'Sharpness'. Press 'OK' to enter sub-menu.
2. Press 'Up/Down' buttons to select Sharp, Normal, Soft or Cancel.
3. Press 'OK' to save and return to the Video Mode.

3g. Effect Settings (Allows to select different image effects)

1. From 'Video Mode', press 'Menu'. Then, press the 'Up/Down' buttons to select the 'Effect', Press 'OK' to enter sub-menu.
2. Press 'Up/Down' buttons to select Normal, B&W, Sepia, Red, Green, Blue, Sunset, Warm, Cool, Over Exposure, IR, Binary, Vivid, Undertone, Dog Eye, Aibao, Gothic, Japan Style, LOMO, Negative or Cancel.
3. Press 'OK' to save and return to Video Mode.

3h. Video Image Sensitivity Settings (ISO)

You can manually adjust video image sensitivity with this function; however, we recommend you use 'Auto' mode – selecting ASA100 – Under Daylight; Selecting ASA 400 – Under LOW Light.

1. From 'Camera Mode', press 'Menu'. Then, press the 'Up/Down' buttons to select 'ISO'.
2. Press 'OK' to enter sub-menu.
3. Press 'Up/Down' buttons to select: Auto, 100, 200, 400 or Cancel from the menu. Press 'OK' to save and return to the video mode.

Note: Refer to the Setup Menu on page 17 for Basic Setup Settings.

4. Shooting Photos and Settings

Turn on the camcorder and press the 'Mode' button to switch to Camera Mode (a camera icon appears).

1. A preview is displayed on the screen.
2. Hold the camcorder still and press the shutter to take a photo.
3. The number of the photos remaining to be taken in each resolution ratio is shown in the top right corner of the screen.
4. "No Card" will show on the screen if there is no SD card in the camera. "Storage Card Full" will show on the screen when the SD card is full. You will need to replace the card to continue taking photos.
5. The number of photos remaining that can be saved is determined by the space left on the SD card and the chosen resolution ratio. The higher the photo quality, the more memory is used. In Camera Mode, some parameters can be changed before shooting which will also affect the number of photos you may save.

4a. Mode Settings

There are several preset multiple scene modes. Use 'Auto' for general use.

1. From Camera Mode, press the 'Menu' button. Then, press 'Up/Down' buttons to select 'Mode Settings'. Press 'OK' to enter the sub-menu..
2. Press the 'Up/Down' to select the mode that you need. Options are: Auto, Night, Portrait, Landscape, Backlight, Sport, Party, Beach, High Sensitivity or Cancel. Press 'OK' to save and return to the Camera Mode.

4b. Resolution Settings

You may set photo resolution as follows:

1. From Camera Mode, press the 'Menu' button. Then, press 'Up/Down' buttons to select 'Resolution Settings'. Press 'OK' to enter the sub-menu.
2. Press the 'Up/Down' buttons to choose the photo size that you need. Options are 48M (8000x6000), 30M (6400x4800), 24M (5600x4200), 20M (5200x3900), 16M (4608x3456), 12M (4000x3000), 10M (3648x2736), 8M (3264x2448) 7MHD (3648x2048), 5M (2592x19944), 3M (2048x1536) or Cancel.
3. Press 'OK' to save and return to Camera Mode.

4c. Beauty Face Settings

This function helps enhance the lo'OK' of skin.

1. From Camera Mode, press the 'Menu' button. Then, press 'Up/Down' buttons to select 'Beauty Face'. Press 'OK' to enter the sub-menu.
2. Press the 'Up/Down' buttons to turn On/Off or Cancel. Press 'OK' to save and return to the Camera Mode.

4d. Shooting Settings

This function will allow the capture of either a single image or 3 continuous shots by pressing the photo button, enabling you to capture great multiple shots.

1. From Camera Mode, press the 'Menu' button. Then, press 'Up/Down' buttons to select 'Shooting Mode'. Press 'OK' to enter sub-menu.
2. Press the 'Up/Down' buttons to select a mode: Single, Continuous, or Cancel.
3. Press 'OK' to save and return to the Camera Mode.

4e. Self-Timer Settings

This delays the photo from being shot for 2s, 5s or 10s after you press the button (self-timer).

1. From Camera Mode, press the 'Menu' button. Then, press 'Up/Down' buttons to select 'Self Timer'. Press 'OK' to enter sub-menu.
2. Press the 'Up/Down' buttons to select: Off, 2 Sec, 5 Sec, 10 Sec, Cancel.
3. Press 'OK' to save and return to the Camera Mode.

4f. Exposure Settings

Manually over- or under-expose a photo.

1. From Camera Mode, press the 'Menu' button. Then, press 'Up/Down' buttons to select 'Exposure'. Press 'OK' to enter sub-menu.
2. Press the 'Up/Down' buttons to select EV values from +3 to -3 or Cancel.
3. Press 'OK' to save and return to the Camera Mode.

4g. White Balance Settings

This function adjusts the color of a photo according to different source conditions.

Use 'Auto' for general purpose.

1. From Camera Mode, press the 'Menu' button. Then, press 'Up/Down' buttons to select 'White Balance'. Press 'OK' to enter sub-menu.
2. Press Up/Down buttons to select: Auto, Daylight, Cloudy, Fluorescent, Tungsten or Cancel. Press 'OK' to save and return to Camera Mode.

4h. Photo Quality Settings

This function sets the quality of your photo. Higher quality will take up more space on your memory card.

1. From Camera Mode, press the 'Menu' button. Then, press 'Up/Down' buttons to select 'Photo Quality'. Press 'OK' to enter sub-menu.
2. Press the 'Up/Down' buttons to select: Super Fine, Fine, Normal or Cancel. Press 'OK' to save and return to Camera Mode.

4i. Sharpness Settings

Adjust the sharpness for clearer or softer edges.

1. From Camera Mode, press the 'Menu' button. Then, press 'Up/Down' buttons to select 'Sharpness'. Press 'OK' to enter sub-menu.
2. Press the 'Up/Down' buttons to select: Sharp, Normal, Soft or Cancel. Press 'OK' to save and return to the Camera Mode.

4j. Effects Settings

You can set a photo effect by the item listed in the Menu.

1. From Camera Mode, press the 'Menu' button. Then, press 'Up/Down' buttons to select 'Effect'. Press 'OK' to enter sub-menu.
2. Press the 'Up/Down' buttons to select the effect desired: Normal, B&W, Sepia, Red, Green, Blue, Sunset, Warm, Cool, Over-Exposure, IR, Binary, Vivid, Undertone, Dog Eye, Aibao, Gothic, Japan Style, LOMO, Negative or Cancel. Press 'OK' to save and return to Camera Mode.

4k. Photo Sensitivity Settings (ISO)

You can manually adjust photo sensitivity with this function.

However, we recommend using 'Auto' Mode, ASA 100 for Daylight or ASA 400 for low light.

1. From Camera Mode, press the 'Menu' button. Then, press 'Up/Down' buttons to select 'ISO'. Press 'OK' to enter sub-menu.
2. Press the 'Up/Down' buttons and select: Auto, 100, 200, 400. Press 'OK' to save and return to the Camera Mode.

4l. Anti-Shake Settings

Use the anti-shake function to reduce the fuzziness/blur caused by hand shaking.

1. From Camera Mode, press the 'Menu' button. Then, press 'Up/Down' buttons to select 'Anti-Shake'. Press 'OK' to enter sub-menu.
2. Press the 'Up/Down' buttons to select: On, Off or Cancel. Press 'OK' to save and return to the Camera Mode.

4m. Face Detect Settings

This function can detect the faces of people in the viewfinder.

1. From Camera Mode, press the 'Menu' button. Then, press 'Up/Down' buttons to select 'Face Detect'. Press 'OK' to save and return to the Camera Mode.

2. Press the 'Up/Down' buttons to select On, Off or Cancel. Press 'OK' to save and return to Camera Mode.
- 4n. Smile Capture Settings
- This function will shoot photos automatically when it detects a smile.
1. From Camera Mode, press the 'Menu' button, then press 'Up/Down' buttons to select 'Smile Capture'. Press 'OK' to enter sub-menu.
 2. Press the 'Up/Down' buttons to select On, Off, or Cancel. Press 'OK' to save and return to Camera Mode.
- 4o. Date Stamp Settings
- The date and time can be marked on the photo.
1. From Camera Mode, press the 'Menu' button, then press 'Up/Down' buttons to select 'Date Stamp'. Press 'OK' to enter sub-menu.
 3. Press Up/Down buttons to select: Off, Date, Date and Time or Cancel. Press 'OK' to save and return to Camera Mode.

Note: Refer to the Setup Menu on page 17 for Basic Setup Settings.

5. Playback Mode

Turn on the camcorder and press the 'Mode' button to switch to 'Playback' Mode.

1. Look at the viewing screen to see your captured videos or photos.
 2. A play arrow icon and the words "JPG" appears if it's a photo.
 3. A film icon and the words "AVI" appears if it's a video.
 4. You can write protect or delete files.
- 5a. Viewing Photos
1. Once you are in Playback Mode, press the 'Up/Down' keys to navigate through thumbnails. Press 'OK' to view a single photo or video.
 2. To use the Zoom Function on Still Photos: To zoom in, push 'Tilt'; to zoom out, push 'Wide'.
 3. When you reach maximum zoom out, you will enter the 'Multiple Thumbnails' option, where you can view multiple files.
 4. To exit from thumbnails, press the shutter button or 'OK' to return to a single photo view.
- 5b. Deleting Photos
- This function deletes one photo or all photos at once.
1. From 'Playback Mode', select a photo, then press 'Menu'. Then, press the Up/Down buttons and select 'Delete'. Press 'OK' to enter the sub-menu.
 2. Press Up/Down buttons to select 'This Image', 'All' or 'Cancel'.
 3. Press 'OK' to confirm this operation. Select 'Yes' or 'No' and press 'OK' to re-confirm.

Note: Protected photo files cannot be deleted.

5c. Protecting Photos

This function protects photos, so they are not accidentally deleted while on the SD card.

1. From 'Playback Mode', select a photo, then press 'Menu'. Then, press the Up/Down buttons and select 'Protect'. Press 'OK' to enter the sub-menu.
2. Press Up/Down buttons and select 'Lock This', 'Unlock This', 'Lock All', 'Unlock All' or 'Cancel'.
3. Press 'OK' to confirm this operation.

5d. Rotating Photos (Not Videos).

This function rotates a chosen photo.

1. From 'Playback Mode', select a photo, then press 'Menu'. Then, press the Up/Down buttons and select 'Rotate'. Press 'OK' to enter the sub-menu.
2. Press Up/Down buttons to select 90°, 180°, 270° or Cancel.
3. Press 'OK' to confirm this operation.

5e. Cropping Photos (Not Videos)

This function crops a chosen photo.

1. From 'Playback Mode', select a photo, then press 'Menu'. Then, press the Up/Down buttons and select 'Crop Image'. Press 'OK' to enter the sub-menu.
2. Press Up/Down buttons to select Crop or Cancel.
3. Press 'OK' to enter 'Crop' mode. Use the 'Zoom' in and out to select the area you want to crop. Then, press 'OK'. Move within the frame to show the newly-cropped image by using 'Zoom' to move left or right or 'Arrow Key' to move up or down. When the photo is the way you want it, press the Shutter button.
4. Press the Shutter button again to save the newly-cropped image.

5f. Slideshow Presentation for Photos (Not Videos)

This function plays a slideshow by automatic playback.

1. From 'Playback Mode' while viewing a .JPEG, press 'Menu'. Then, press the Up/Down buttons and select the 'Slide' option. Press 'OK' to enter the sub-menu.
2. Press 'Up/Down' buttons to select: 3, 5, 10 Seconds, or Cancel.
3. Press 'OK' to confirm and display the slideshow. Press again to quit.

5g. Playing Videos

All recorded video files can be viewed, protected or deleted.

1. To play a selected video file, press the 'Record' button.
2. To pause, press the 'OK' button and press 'OK' again to continue video play.
3. Press 'Record/Stop' to stop and exit.

5h. Deleting Video Files

This function deletes one video or all videos at once.

1. From 'Playback Mode', select a video, then press 'Menu'. Then, press the Up/Down buttons and select 'Delete'. Press 'OK' to enter the sub-menu.
2. Press Up/Down buttons to select 'This Video', 'All' or 'Cancel'.
3. Press 'OK' to confirm this operation. Select 'Yes' or 'No' and press 'OK' to re-confirm.

Note: Protected video files cannot be deleted.

5i. Protecting Videos

This function protects videos, so they are not accidentally deleted while on the SD card.

1. From 'Playback Mode', select a video, then press 'Menu'. Then, press the Up/Down buttons and select 'Protect'. Press 'OK' to enter the sub-menu.
2. Press Up/Down buttons and select 'Lock This', 'Unlock This', 'Lock All', 'Unlock All' or 'Cancel'.
3. Press 'OK' to confirm this operation.

6. Basic Settings

You can set the time/date, language and other options from the 'Setup Menu'.

6a. Language Settings

This unit supports English and a number of other languages.

1. From Camera Mode, press 'Menu'. Then, press the Up/Down buttons and select 'Setup'. Press 'OK' to enter the sub-menu.
2. Press the Up/Down buttons to select the language: English, Deutsche, French, Spanish, Italian, Turkish, Russian, Portuguese, Nederland, Simplified Chinese, Traditional Chinese, Japanese or Polish. Press 'OK' to save and return to the setup menu.

6b. Date and Time Settings

Users can set the date and time on the camcorder.

1. From Camera Mode, press 'Menu'. Then, press the Up/Down buttons and select 'Setup'. Press 'OK' to enter the sub-menu.
2. The screen will display date and time options, with the year highlighted as the first parameter.
3. Set each parameter: "YY/MM/DD/hr/min/sec" and press the Record/Stop button to toggle between each. Use the Up/Down arrows to change the values of each parameter.
4. Press 'OK' to save and return to the setup menu.

6c. Auto Power Off Settings

This option will automatically power off the unit, after the set amount of time, to save power.

1. From Video or Camera Mode, press 'Menu'. Then, press the Up/Down buttons to select 'Setup'. Press 'OK' to enter the sub-menu.
2. Press the Up/Down buttons to select 'Power Save', then select: Off, 1 Min., 3 Min., 5 Min. or Cancel. Press 'OK' to save and return to the setup menu.

6d. Beep Settings

This function will turn on and off beeping sounds made by pushing various keys.

1. From Video or Camera Mode, press 'Menu'. Then, press the Up/Down buttons to select 'Setup'. Press 'OK' to enter the sub-menu.
2. Press the Up/Down buttons to select 'Beep'.
3. Press 'OK' button to select: On, Off or Cancel.
4. Press 'OK' to save and return to the setup menu.

6e. Light Frequency Settings

This function avoids the image flickering when shooting (for the US market, use 60Hz).

1. From Video or Camera Mode, press 'Menu'. Then, press the Up/Down buttons to select 'Setup' option. Press 'OK' to enter the sub-menu.
2. Press the Up/Down buttons to select 'Light Frequency'.
3. Press 'OK' to select: 60Hz, 50Hz or Cancel.
4. Press 'OK' to save and return to the setup menu.

6f. Format Function (Deletes Stored Memory!)

This function will format the SD card.

Important! This will permanently delete any data already stored on the memory card!

1. From Video or Camera Mode, press 'Menu'. Then, press the Up/Down buttons to select 'Setup'. Press 'OK' to enter the sub-menu.
2. Press the Up/Down buttons to select 'Format'.
3. Press 'OK' to select: 'Yes/No'.
4. Select 'Yes' or 'No' and press 'OK' to re-confirm you want to format the SD Card.

6g. Default Setting

This function will reset the camcorder to factory settings. It will not delete the data already saved on the SD card. The language will remain English as the default.

1. From Video or Camera Mode, press 'Menu'. Then, press the Up/Down buttons to select 'Setup'. Press 'OK' to enter the sub-menu.
2. Press the Up/Down buttons to select 'Default Setting'.
3. Press Up/Down to choose: 'Yes' or 'No'.
4. Select: 'Yes' or 'No' confirm again, Press 'OK' to select and return to Camera Mode.

7. Webcam Mode

1. Connect your computer to the camcorder via USB cable, while the power is off.
2. Turn the camcorder on. Two options will be displayed on the screen: "MSDC" and "PC-CAM". Select "PC-CAM" and press OK to confirm..
Note: Most computers will have this driver. If not, the computer will prompt for a driver installation. Follow the prompts to complete installation.
3. Open any application/program that requires a webcam.
Note: Some applications/programs requires an extra step to select the device (check the applicable device setting of the program you will use).

8. Appendix

8a. Technical Specifications

Sensor	CMOS Sensor, Max. 30MP (software interpolation)
Sensitivity	Auto, ISO100, ISO200, ISO400
Storage Media	Supports C10 (or higher) SD Card, Max. 128GB
Lens	Fixed Lens, F/2.6, f=7.0mm
Focus Range	Normal: 1m~Infinity
Image Resolution	File Format: JPEG 48M (8000x6000), 30M (6400x4800), 24M (5600x4200), 20M (5200x3900), 16M (4608x3456), 12M (4000x3000), 10M (3648x2736), 8M (3264x2448), 7MHD (3648x2048), 5M (2592x1944), 3M (2048x1536)
Video Resolution	File Format: AVI Resolution: 2.7K (2688x1520), FHD (1920x1080), HD (1280x720), VGA (640x480)
Zoom	18x Digital Zoom
Anti-Shake	Supports (Electronics Solution)
Face Detect	Supports
Video Sounds	Supports
Screen	3.0" IPS Screen
LED Light Range	<1.0m
White Balance	Auto, Daylight, Cloudy, Fluorescent, Tungsten
Exposure Compensation	-3.0EV~+3.0EV
Self Timer	Off, 2 Sec, 5 Sec, 10 Sec,
PC Interface	USB 2.0
External Microphone	Supports. Available HDV17-MIC (sold separately)
Auto Power Off	Off, 1 min, 3 mins, 5 mins
Power	NP-40 Lithium Battery
Dimension	4.99" (L) x 2.28" (W) x 2.32" (H)
Weight	Approx. 0.66 lbs.

8b. Troubleshooting

Issue	Possible Causes	Solutions
Unbootable	Battery not installed properly. Battery not charged.	Properly install battery according to the manual. Charge the battery.
Suddenly shutdown	Power-saving function setting. Battery not charged.	Reset power save function. Charge battery.
Can't store a photo or video	Power was interrupted before storing	When battery indicator is red, immediately use a new battery or charge it.
Automatically closed when shooting	No battery power	Charge or change battery.
Ambiguously focusing	Out of focus range or open micro switch	Shoot in focus range or choose normal or micro mode.
Can't use memory card	Protected memory card or error during format. Possible damaged card.	Release memory card's write protection. Format memory card or use a new one.
Inaction of all keys	Short circuit in connection of the unit and the other device	Check the connecting circuit. Take out the battery and try opening and closing unit.

Product Registration Instructions

Visit: www.HamiltonBuhl.com

- 1 . Click on Customer Care.
- 2 . Click on Product Registration Form.
- 3 . Please fill out all fields marked with * to register your product.

Warranty:

Warranty begins the date item ships from our warehouse.

All products have a one year warranty from original date of shipment, unless otherwise noted.

